

EUROPOOL

Your own luxury pool

Official UK
distributor of
Europool's
products

Starlight
Pools



About the company 4

Swimming pool comparison 6

Fiberglass pools 8

Josef, Mike, Wicek	10
Kinderpool	12
Victoria, Mini Victoria	14
Saba 500, Saba 600	16
Papeete 600, Papeete 700	18
Grenada 600, Grenada 700	20
Bali 650, Bali 750	22
Bahama 600, Bahama 1100	24
Tropea	26
Farris 650, Farris 800	28
Aves 705, Aves 800	30
Haiti	32
Tortola 800, Tortola 1000	34
Panama	36
Aruba Plus	38
Aruba 720, Aruba 820	40
Barbados	42
Trinidad	44
Hawana	46
Jamaika	48



Polypropylene pools 50

Covers

Solar foil	56
Secure cover	57
Roller Schutter	58

Enclosures 60

Low Line

Skyline	62
Gravity	62
Cosmos	62
Discovery	62
Stardust	62

Medium Line

Horizon	63
Orbit	63
Cometa	64
Eclipse	64
Lunar	64

We believe that there is no need to be a big company to achieve big goals. Our goal is big, but simple - we want to have the most satisfied customers in the world.

High Line

Panorama	65
Orbit Up	65
Cometa Up	66
Lunar Up	66
Skyline Up	66

Double Line

Cometa Double	67
Skyline Double	67
Horizon Double	68
Orbit Double	68
Lunar Double	68

SPA Line

Area SPA	69
Aurora SPA	69
SPA Zone	69
Copula	69



Terrace Line

Sunlight	70
Daylight	70
Skywall	71
Moonlight	71

Filter box

72

Swimming pool technology

Basin equipment	74
Pumps and filters	75
Water purifying	76
Water heating	77
Additional equipment	78

Installation and transport

80

Our pools

82

**Enjoy life even more, together
with everyone you love.**

EUROPOOL

Your own luxury pool



We are a Polish manufacturer of swimming pools that has been on the market since 2007. The main area of our activity is the production of a wide range of vinylester and polypropylene pools, which, thanks to many years of experience, are characterised by the highest quality. Our offer also includes enclosures, roller blinds, and pool covers, as well as pool technology.

We have over 30 models of fiberglass swimming pools; the shape and dimensions are adapted to the needs of our clients. We are the only Polish company which produces polypropylene pools with unlimited shapes of form dependent on the consumer's individual preferences. Our diversified portfolio of products makes even the most demanding customers satisfied.

One of the essential features of our company is striving for its continuous development. Years of experience in the pool industry have contributed to creation of **EuropoolSpa**, our line of unique and original spa tubs of the highest quality and style.

However, the product itself is not enough to satisfy customers' needs and we are fully aware of it. That is why we deal with the manufacturing and a comprehensive range of services from pool design through arrangement and transport.

Do you deserve luxury, pleasure and health?
Of course you do.



Europool
0120001

Your own luxury pool

Fiberglass pools

- ✓ made of a vinylester resin,
- ✓ possibility of heating water up to 30°C,
- ✓ can be made only in skimmer technology,
- ✓ solid colour,
- ✓ smooth surface,
- ✓ insulated with polyurethane foam,
- ✓ no possibility of changing the size and shape.

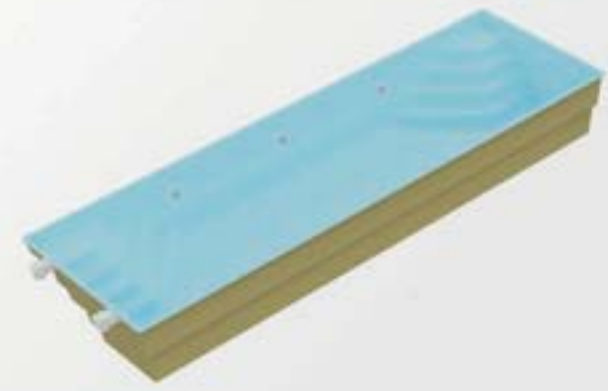

Polypropylene pools

- ✓ made of polypropylene plates with a thickness of 8 and 15mm, joined by diffusion welding,
- ✓ special temperature resistance from -20°C to 72°C,
- ✓ possibility of production in two technologies:
 - skimmer or overflow gutter
- ✓ the ability to combine colours,
- ✓ slightly perceptible welds,
- ✓ insulated with styrodur,
- ✓ possibility to create an individual design.

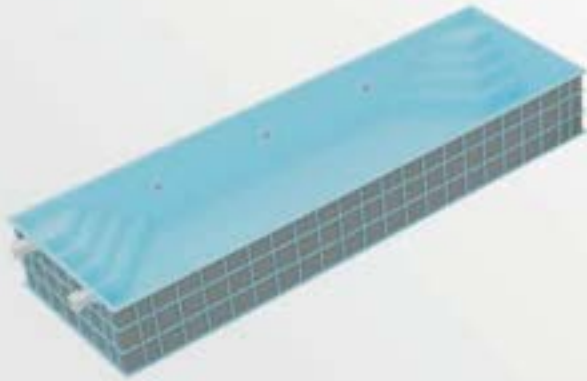

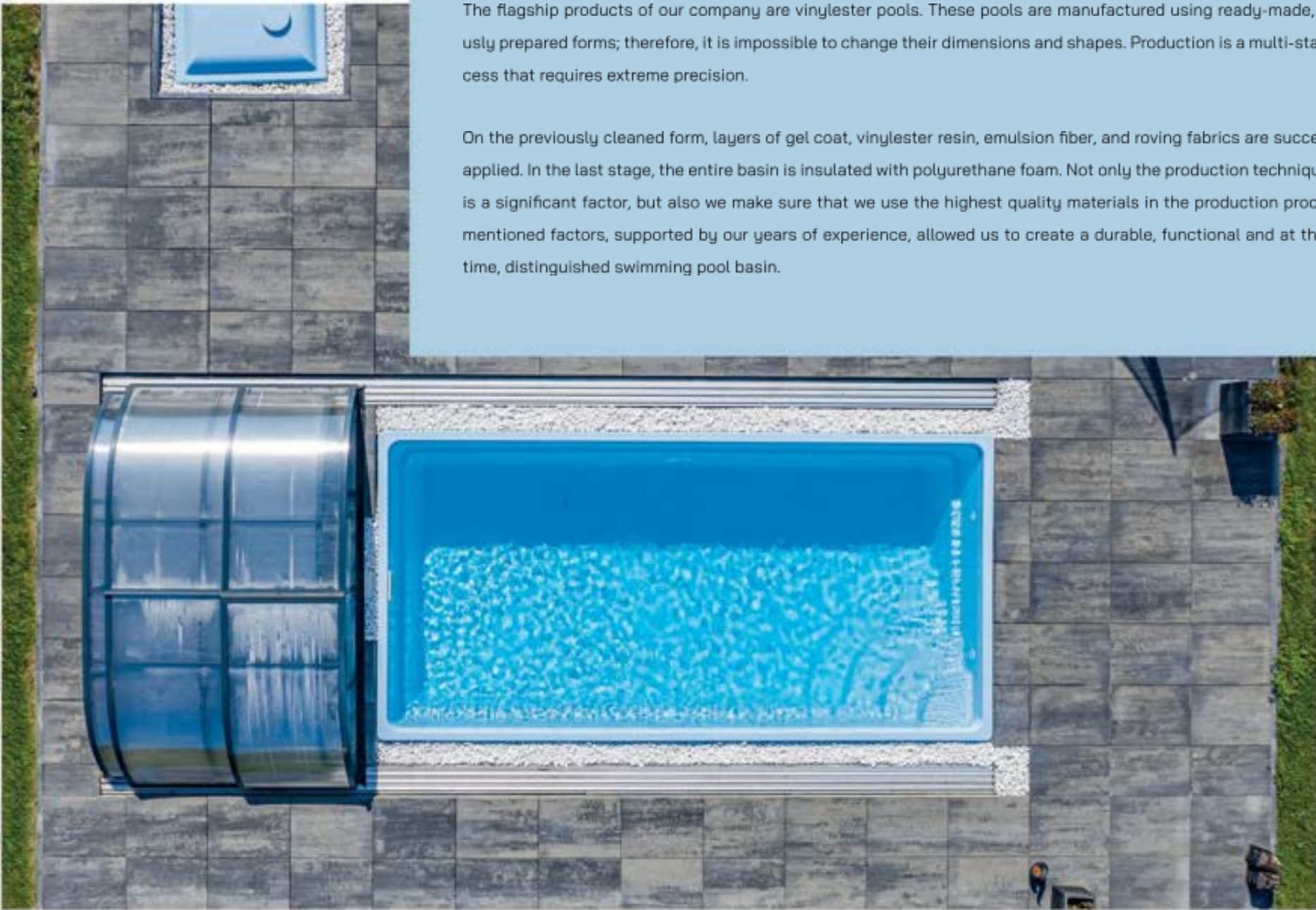

The flagship products of our company are vinylester pools. These pools are manufactured using ready-made, previously prepared forms; therefore, it is impossible to change their dimensions and shapes. Production is a multi-stage process that requires extreme precision.

On the previously cleaned form, layers of gel coat, vinylester resin, emulsion fiber, and roving fabrics are successively applied. In the last stage, the entire basin is insulated with polyurethane foam. Not only the production technique itself is a significant factor, but also we make sure that we use the highest quality materials in the production process. All mentioned factors, supported by our years of experience, allowed us to create a durable, functional and at the same time, distinguished swimming pool basin.

Fiberglass pools



Your own luxury pool

Josef

- Dimension: 2,07 x 2,07 x 1,06m
- Volume: 1,8m³
- Water surface: 4m²
- Pool weight: 85kg

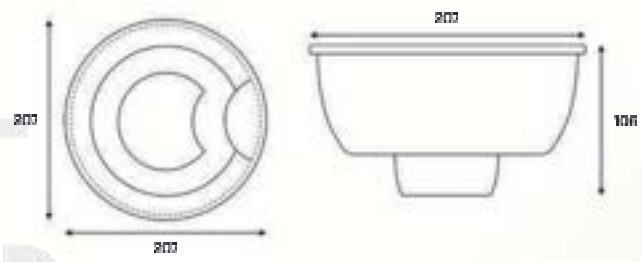

Mike

- Dimension: 2,20 x 1,90 x 1,00m
- Volume: 2,3m³
- Water surface: 4m²
- Pool weight: 90kg

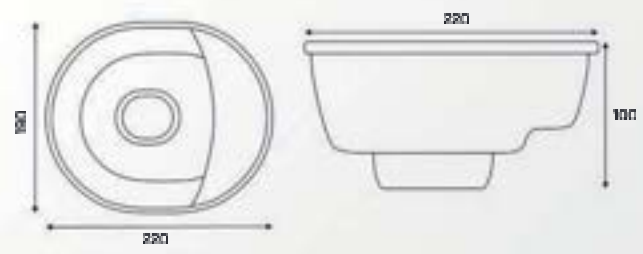

Wicek

- Dimension: 2,30 x 2,90 x 0,90m
- Volume: 3,2m³
- Water surface: 6m²
- Pool weight: 80kg





Josef, Mike, Wicek

Your own luxury pool

Kinderpool

- Dimension: 5,00 x 3,00 x 0,50m
- Volume: 6,5m³
- Water surface: 14m²
- Pool weight: 220kg

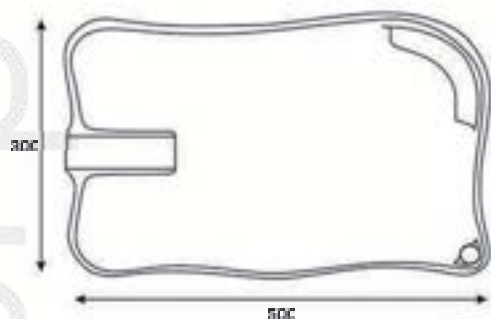





Victoria

 Dimension: 4,70 x 2,70 x 1,30m

 Volume: 12,5m³

 Water surface: 13m²

 Pool weight: 430kg

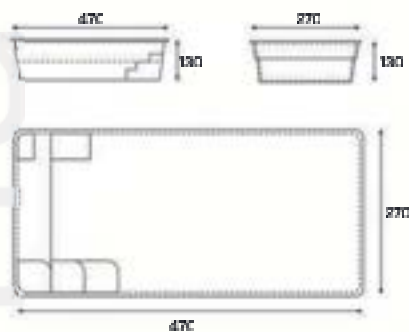

Mini Victoria

 Dimension: 4,20 x 2,70 x 1,30m

 Volume: 11m³

 Water surface: 11,5m²

 Pool weight: 340kg

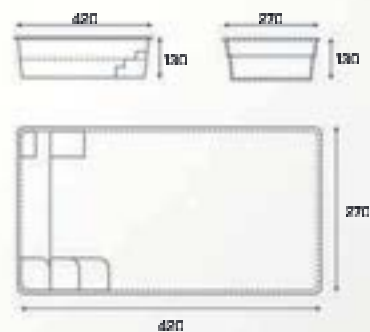



Your own luxury pool

Saba 500

📏 Dimension: 5,00 x 3,00 x 1,45m

📦 Volume: 17,5m³

🌊 Water surface: 15m²

🏊 Pool weight: 470kg

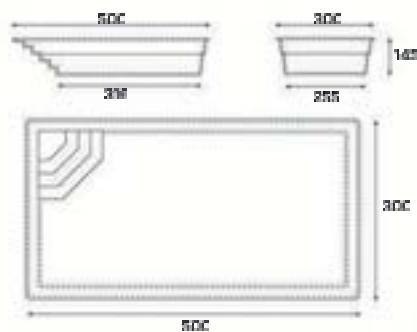

Saba 600

📏 Dimension: 6,00 x 3,00 x 1,45m

📦 Volume: 21m³

🌊 Water surface: 18m²

🏊 Pool weight: 570kg

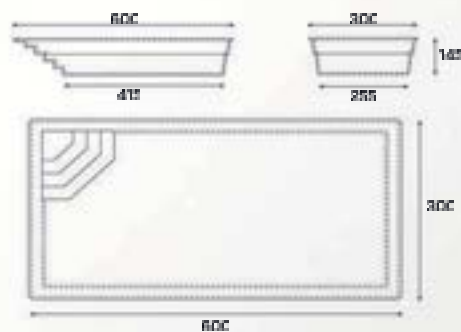

Saba



Papeete 600

- Dimension: 6,00 x 3,00 x 1,50m
- Volume: 22m³
- Water surface: 18m²
- Pool weight: 570kg

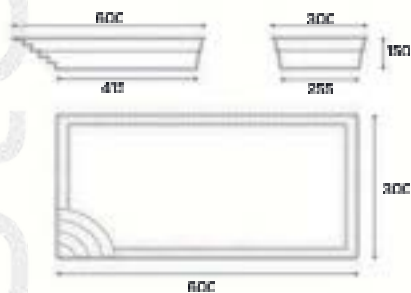

Papeete 700

- Dimension: 7,00 x 3,50 x 1,50m
- Volume: 31,5m³
- Water surface: 24,5m²
- Pool weight: 830kg

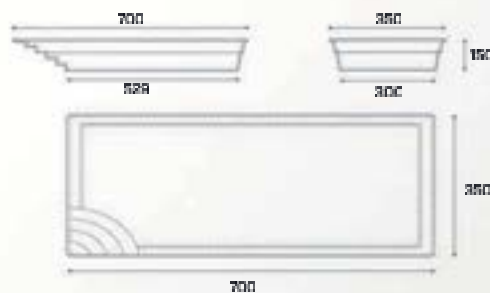



Grenada 600

- Dimension: 6,00 x 3,00 x 1,52m
- Volume: 18,5m³
- Water surface: 17m²
- Pool weight: 580kg

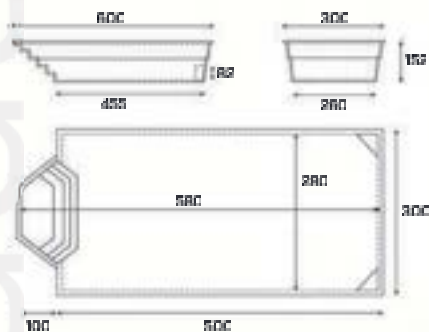

Grenada 700

- Dimension: 7,00 x 3,00 x 1,52m
- Volume: 31,5m³
- Water surface: 19,5m²
- Pool weight: 640kg

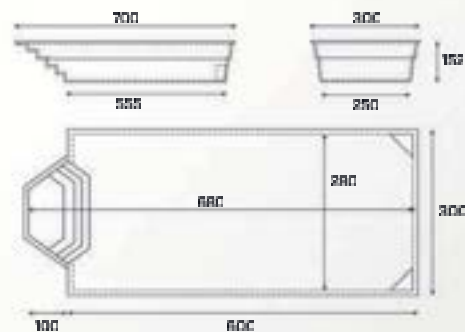



Bali 650

 Dimension: 6,50 x 3,70 x 1,50m

 Volume: 35m³

 Water surface: 24m²

 Pool weight: 700kg



Bali 750

 Dimension: 7,50 x 3,70 x 1,50m

 Volume: 42m³

 Water surface: 28m²

 Pool weight: 900kg



Bali



Your own luxury pool

Bahama 600

- Dimension: 6,10 x 3,75 x 1,50m
- Volume: 23,5m³
- Water surface: 23m²
- Pool weight: 650kg

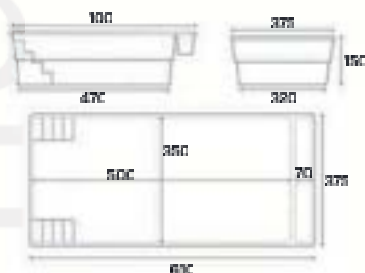

Bahama 1100

- Dimension: 11,10 x 3,75 x 1,50m
- Volume: 51,5m³
- Water surface: 41,5m²
- Pool weight: 1380kg

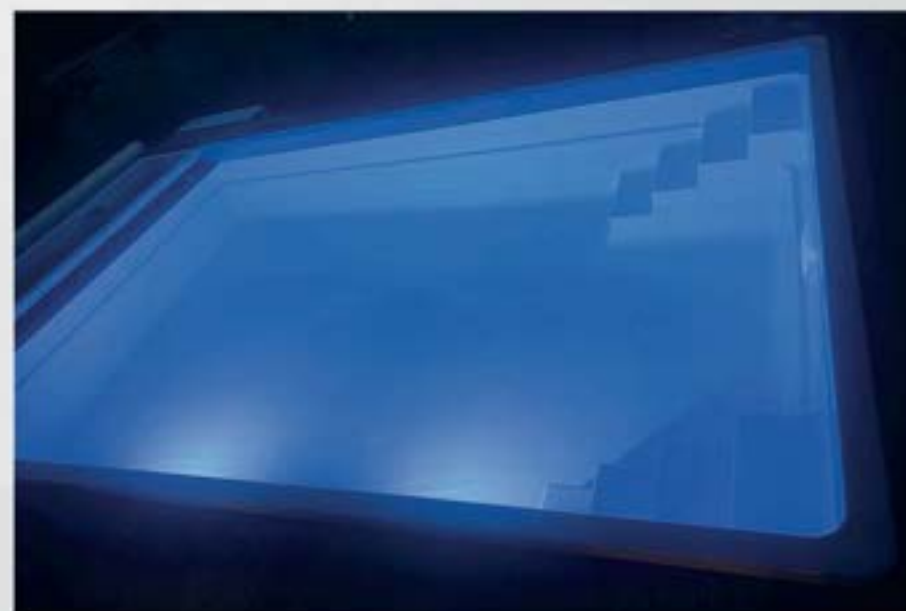
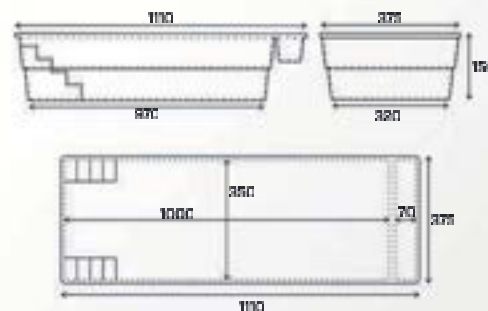



Your own luxury pool

Tropea

📏 Dimension: 6,20 x 3,70 x 1,50m

📦 Volume: 29,5m³

🌊 Water surface: 23m²

🏊 Pool weight: 680kg

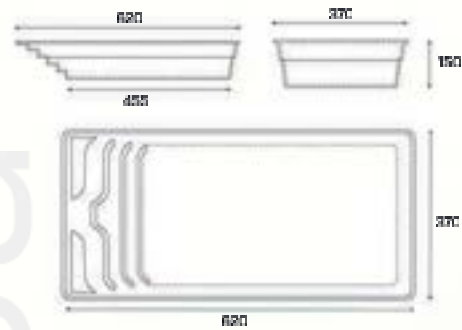



Tropaea

Your own luxury pool

Farris 650

 Dimension: 6,50 x 3,20 x 1,50m

 Volume: 31m³

 Water surface: 20m²

 Pool weight: 650kg

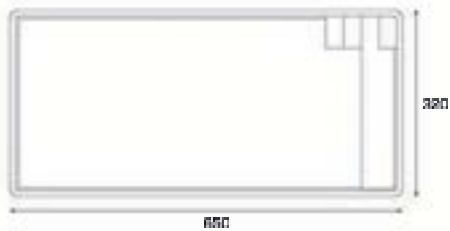

Farris 800

 Dimension: 8,00 x 3,20 x 1,50m

 Volume: 38,5m³

 Water surface: 26m²

 Pool weight: 850kg





Aves 705

- Dimension: 7,05 x 3,20 x 1,55m
- Volume: 26,5m³
- Water surface: 22,5m²
- Pool weight: 710kg

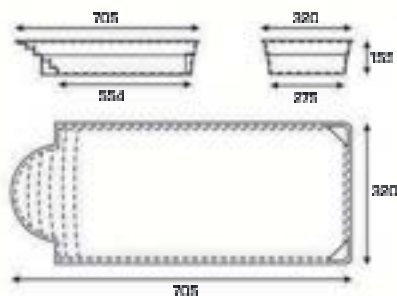

Aves 800

- Dimension: 8,00 x 3,20 x 1,55m
- Volume: 31m³
- Water surface: 25,5m²
- Pool weight: 850kg

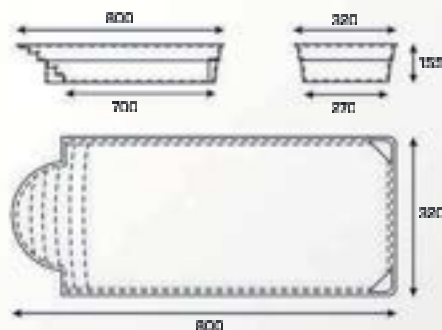



Aves
VES

Haiti

 Dimension: 8,00 x 3,20 x 1,52m

 Volume: 31m³

 Water surface: 25,5m²

 Pool weight: 840kg

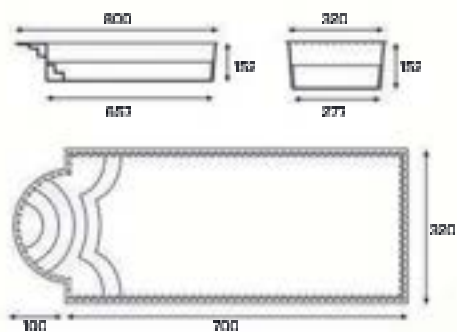



Tortola 800

- Dimension: 8,00 x 3,70 x 1,50m
- Volume: 38,2m³
- Water surface: 27,3m²
- Pool weight: 900kg

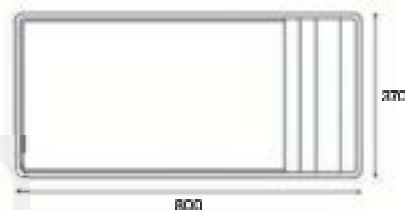

Tortola 1000

- Dimension: 10,00 x 3,70 x 1,50m
- Volume: 48m³
- Water surface: 34,3m²
- Pool weight: 1300kg





Dimension: 8,00 x 3,70 x 1,50m

Volume: 36m³

Water surface: 29,6m²

Pool weight: 900kg





Panama Panama

Your own luxury pool

Aruba Plus

- Dimension: 8,00 x 3,70 x 1,50m
- Volume: 37m³
- Water surface: 29,5m²
- Pool weight: 950kg

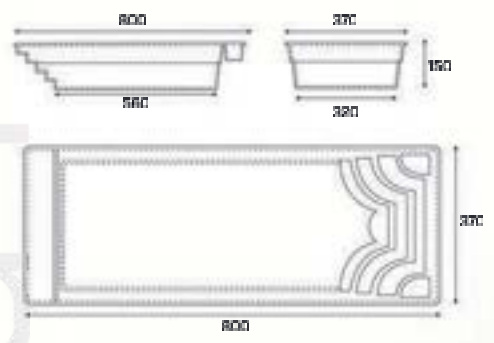



Aruba Plus

Your own luxury pool

Aruba 720

- Dimension: 7,20 x 3,70 x 1,50m
- Volume: 34m³
- Water surface: 26,5m²
- Pool weight: 860kg

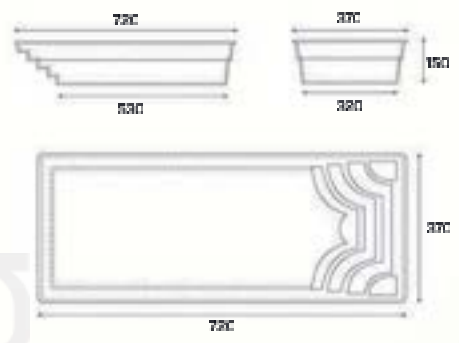

Aruba 820

- Dimension: 8,20 x 3,70 x 1,50m
- Volume: 39m³
- Water surface: 30m²
- Pool weight: 945kg

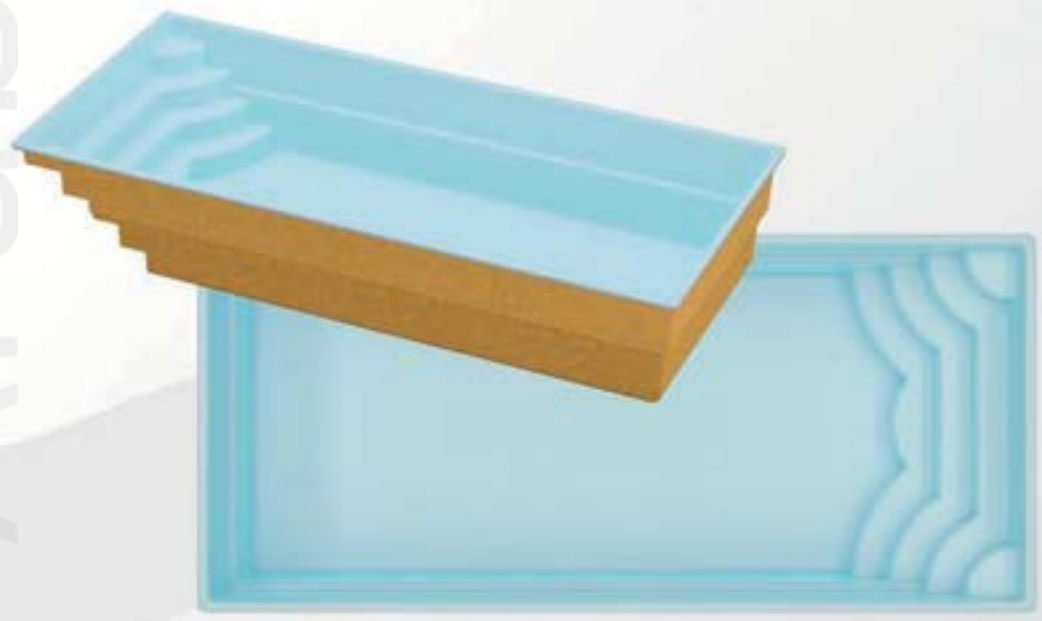
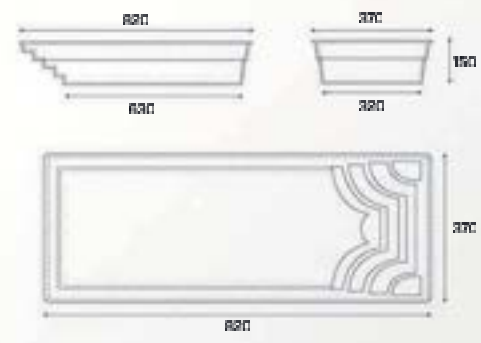



Barbados

- Dimension: 9,40 x 3,70 x 1,50m
- Volume: 41m³
- Water surface: 35m²
- Pool weight: 1180kg

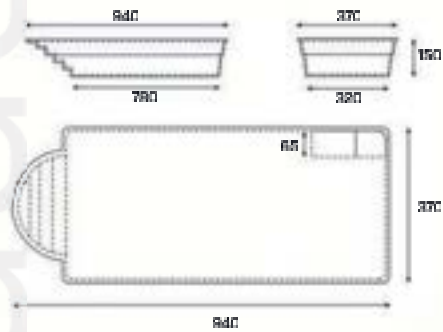



Trinidad

 Dimension: 9,70 x 3,70 x 1,60m

 Volume: 46m³

 Water surface: 36m²

 Pool weight: 1250kg

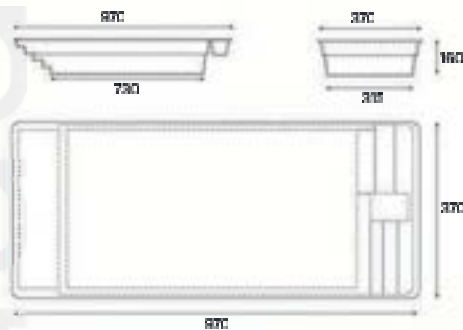



Your own luxury pool

Hawana

- Dimension: 10,00 x 3,70 x 1,50m
- Volume: 48m³
- Water surface: 37m²
- Pool weight: 1350kg

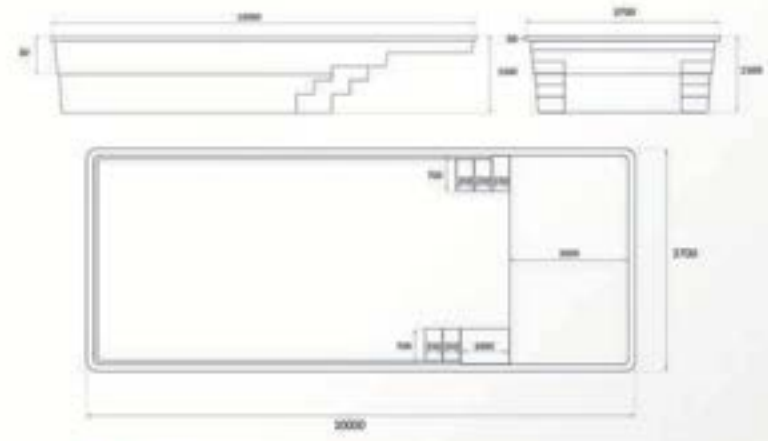



Hawana
QWana

Jamaika

 Dimension: 11,25 x 3,75 x 1,50m

 Volume: 53m³

 Water surface: 42m²

 Pool weight: 1420kg

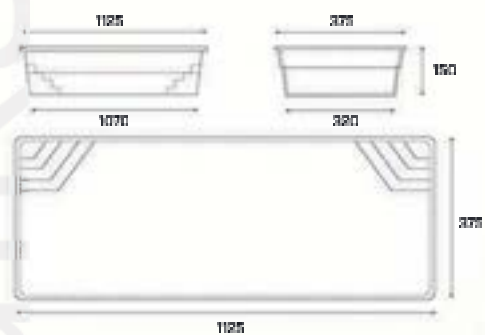



Jamaika
Jamaika
Jamaika

Your own luxury pool



Our offer includes pools made of polypropylene plates. The shape and size are not limited and depend on the customer's preferences. The highest quality material is used for this type of pool, characterised by high colour stability and protection against UV radiation.

The pools are made of solid polypropylene plates with high mechanical strength and resistance to weather conditions. PP plates are connected using the innovative technology of diffusion welding. The pool's surface is smooth, making it easier to clean the pool. Basin is reinforced on the outside with ribs made of the same material.

Advantages:

- ✓ possibility to create an individual design,
- ✓ possibility of production in two technologies:
skimmer or overflow gutter,
- ✓ higher resistance to high temperature,
- ✓ less prone to discoloration.





Personalisation

Strength of material

UV stabilisation

Resistance to heat

Diversity

Your health

Make your design



1.

Choose a technology

Skimmer



Overflow

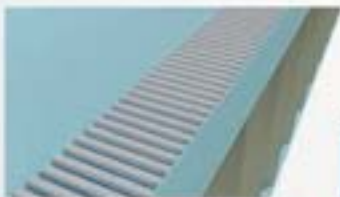

2.

Choose your steps

Choose your steps from the Europool offer or propose your design.



3.

Decide on the underwater roller blind chamber

Decide whether you choose an underwater roller blind as a cover for your swimming pool.



5.

Choose your colour

Colour your swimming pool as you wish by choosing a colour from the Europool colour palette.



4.

Make your design

Think about the dimensions and shape of your pool and our graphic designers will make a sketch of your pool.



6.





3D Visualisation

Europool creates a final visualisation of your swimming pool.



PP Tub

One product multiple applications

-  Dimension: 2,20 x 2,20 x 1,115
-  Volume: 4m³
-  Water surface area: 2,5m²
-  Weight: 650kg

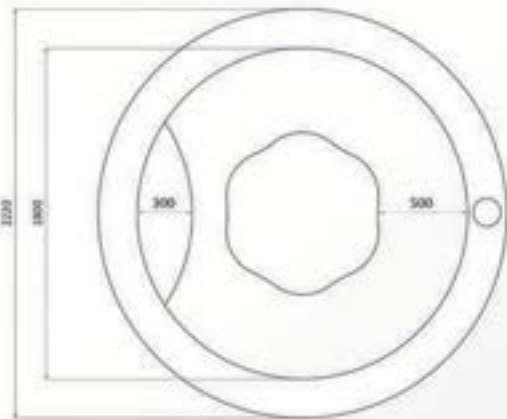

- the housing available in several variants,
- can be heated, cooled or used as a Jacuzzi,
- integrated technology,
- long service life,
- free-standing with the option of installation,
- up to 12 massage jets can be installed.
- LED lamp



Your own luxury pool





Polypropylene pools

Your own luxury pool

Solar foil

Solar foil is the basic form of covering the pool and securing it against the dirt. It consists of a blue, stiff foil 400 microns thick, placed on a winder.

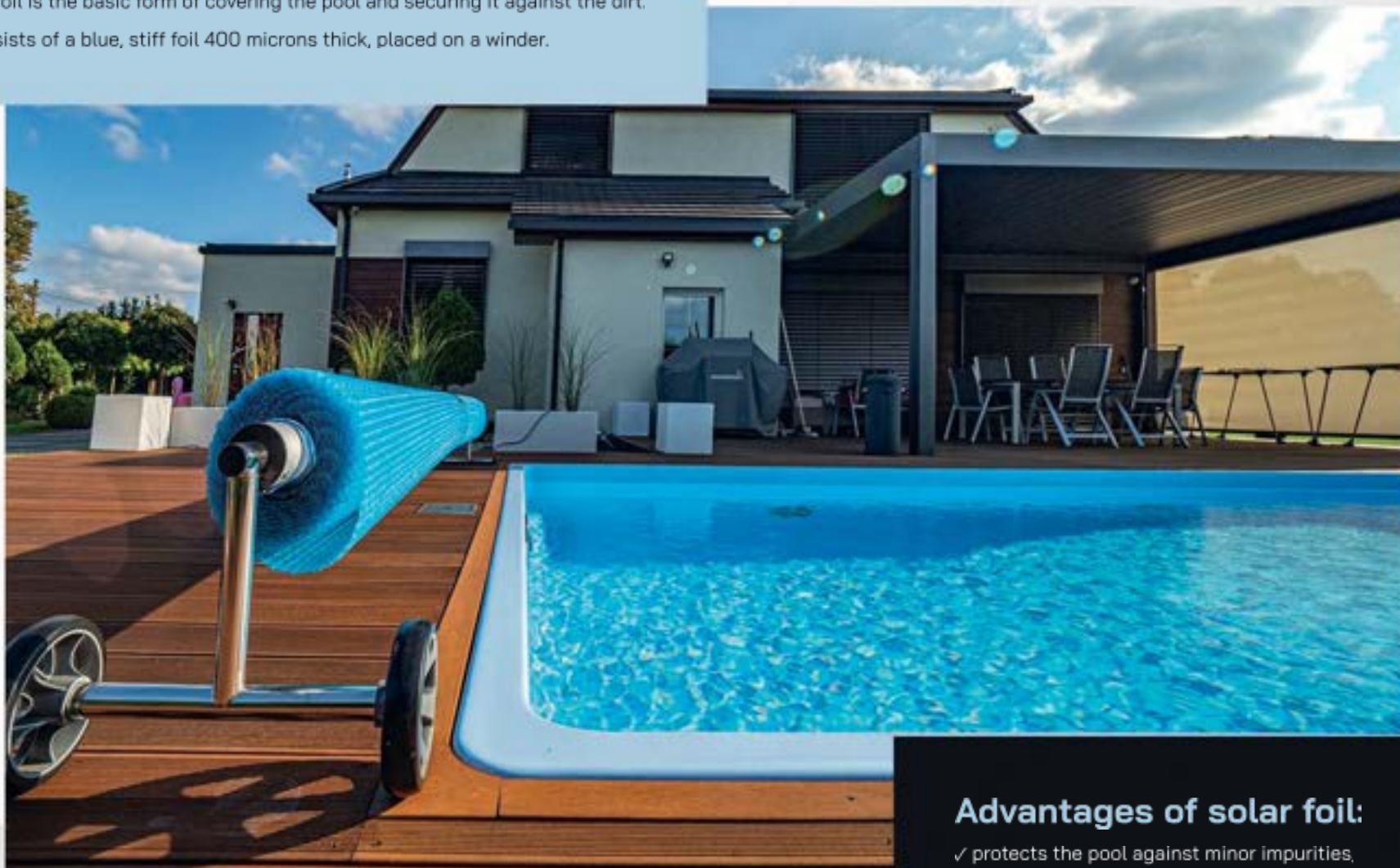

Advantages of solar foil:

- ✓ protects the pool against minor impurities,
- ✓ reduces heat loss and evaporation,
- ✓ easy to use.

Colours available



Secure cover

All-year-long cover reinforced with a frame made of aluminum pipes. It is the perfect protection for the swimming pool during the winter.

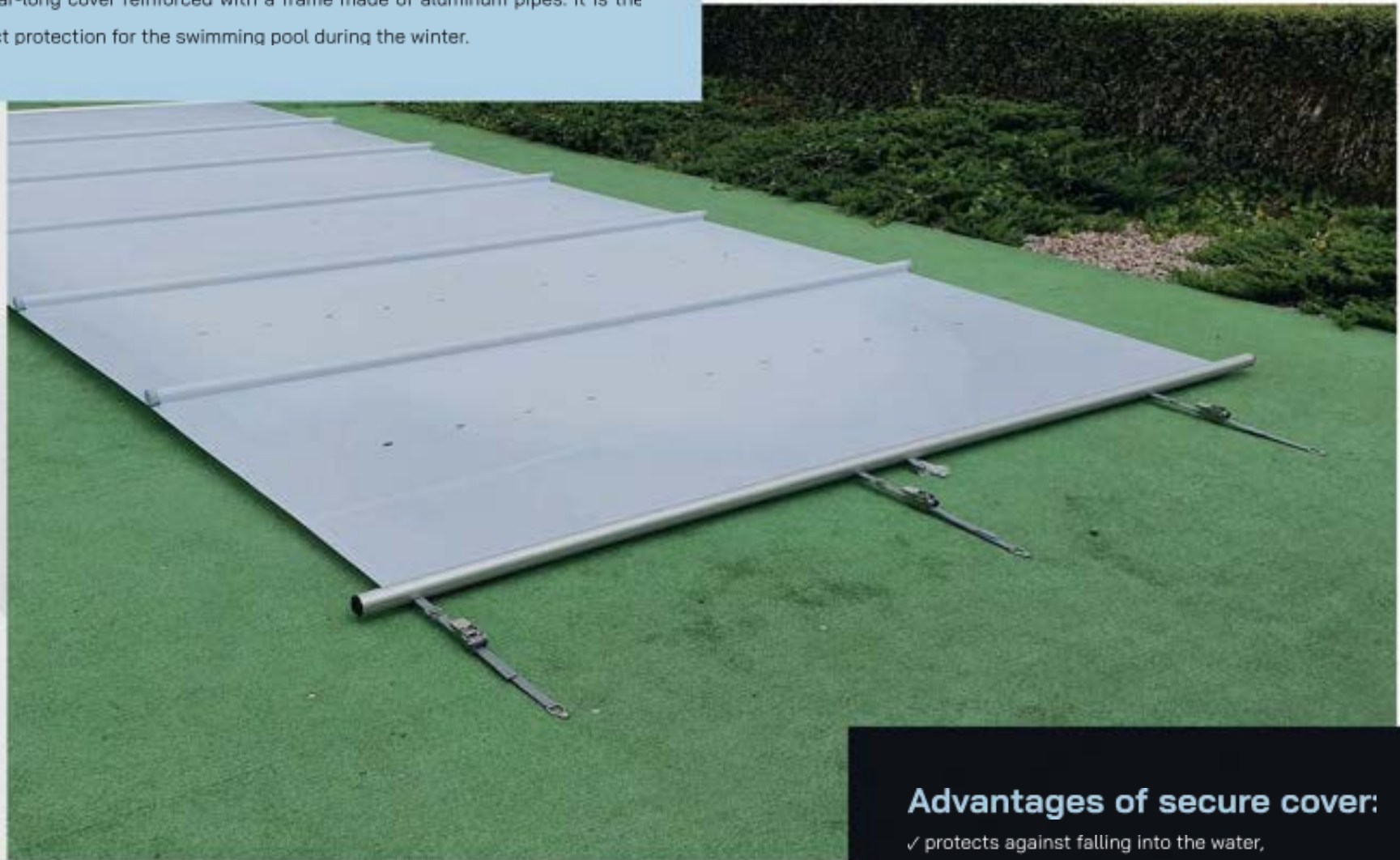

Advantages of secure cover:

- ✓ protects against falling into the water,
- ✓ reduces water evaporation,
- ✓ secures the swimming pool for the winter period

Roller shutter

The roller blind is one of the most popular pool covers. It comes in two variants: a surface roller shutter and an underwater roller shutter, used in pools with a special built-in chamber where the device is installed.

Colours available



Advantages of roller blind:

- ✓ maintains a higher water temperature,
- ✓ protects against impurities,
- ✓ reduces water evaporation,
- ✓ eliminates dangerous situations involving children, animals and even adults

Treat yourself and your loved ones to a moment of pleasure.

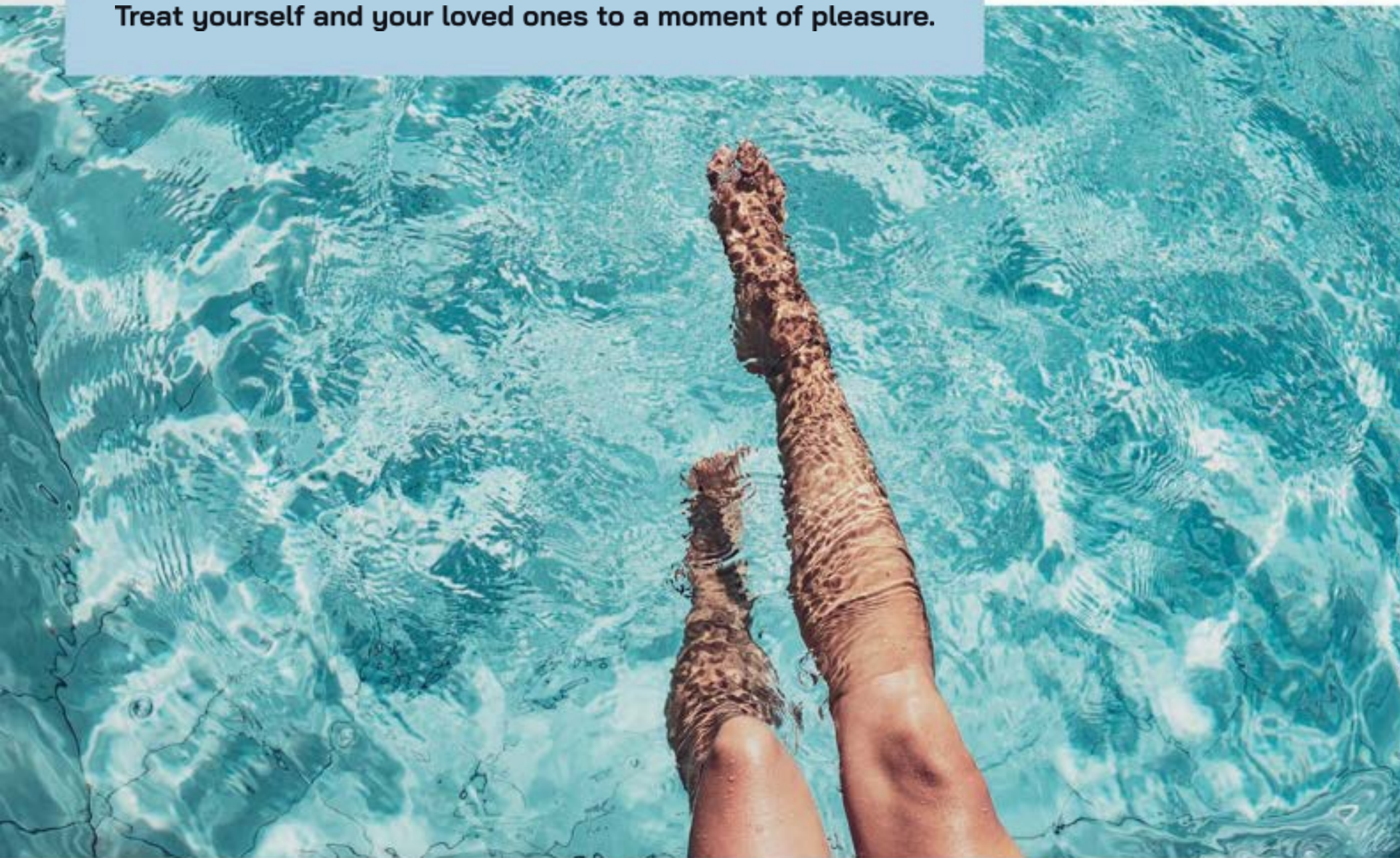

Europool 0100001

Enclosures

The enclosure is the best way to protect your swimming pool. Each product is selected according to the client's preferences to satisfy them with the completed project. The satisfaction and joy of the buyer are our priority.



Possibilities of enclosure configuration:

- ✓ roofing in a box or assembled on a pallet,
- ✓ solid pk3, pk4 or chamber pk8 filling,
- ✓ profile colors: anthracite DB 703, gray RAL 9007 and black RAL 9004,
- ✓ door: right, left, in the front wall,
- ✓ a door knocker necessary in case of choosing a water curtain or a water curtain (excludes the use of a door in the front wall)



Advantages of a pool enclosure:

- ✓ complete security,
- ✓ protection of the swimming pool against UV radiation,
- ✓ reduction of water evaporation,
- ✓ maintaining the proper PH level,
- ✓ limitation of water cooling,
- ✓ extend the service life from early spring to late fall.

Skyline



Gravity



Cosmos



Discovery

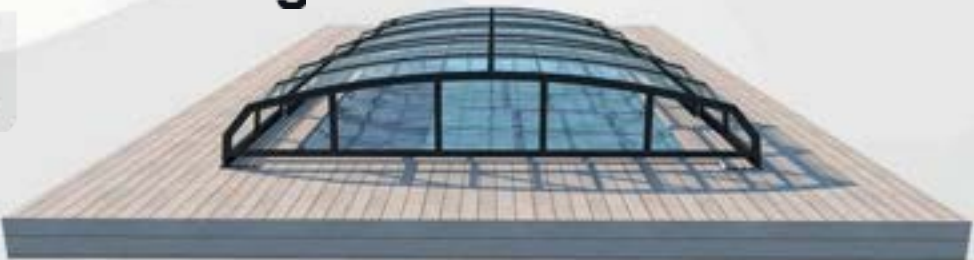

Stardust



Horizon



Orbit



Cometa



Eclipse



Lunar

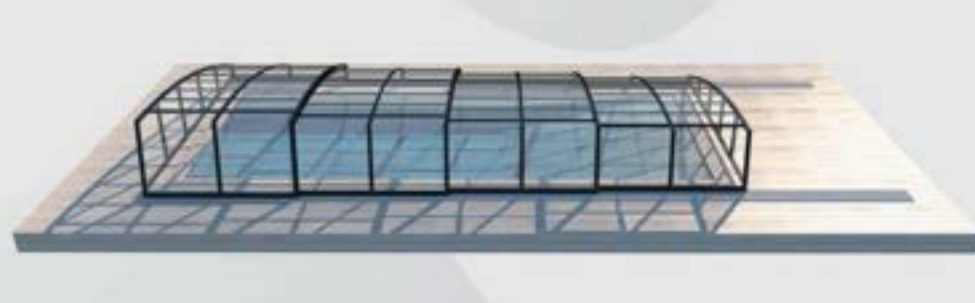

Panorama



Orbit Up



High Line

ine

Cometa Up



Lunar Up



Skyline Up



Cometa Double



Skyline Double



Horizon Double



Orbit Double



Lunar Double

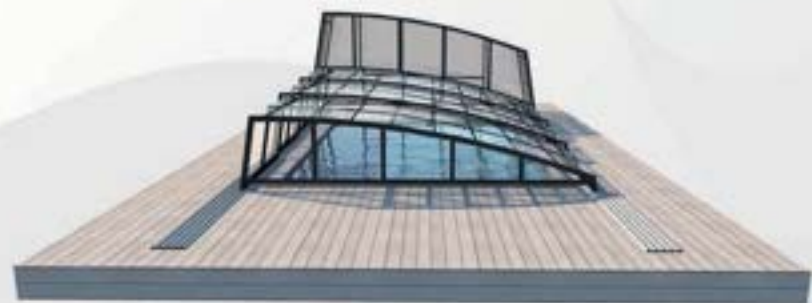

Area SPA



Aurora SPA



SPA Zone



Copula



Sunlight



Daylight



Skywall



Moonlight



Filter box

The filter box is a comprehensive solution for installing all filtering technology. It finds it's application when installing devices in a basement or a wooden house is impossible

The filter box is made of durable materials, which we use to produce our pools.

Technical box small

Dimension: 1,41 x 0,84 x 0,71m



Technical box medium

Dimension: 1,45 x 1,11 x 1,07m



Technical box medium double

Dimension: 1,93 x 1,11 x 1,07m



Technical box big

Dimension: 2,17 x 1,70 x 1,23m



Technical house

We recommend building or purchasing a ready-made, free-standing technical house on a stable, hardened surface. The integrated filtration is easily accessible and comfortable for the user. Garden houses perfectly protect devices against possible rainfall.



Filter box for pool

Basin equipment

Nozzles

They enable the return of purified water from the filter to the inside of the pool. Nozzles can be made of two materials: white ABS (we can paint it in the color of the pool) or stainless steel.



Skimmer

Takes water from the pool to the inside of the filter collecting small impurities (leaves, insects, etc.) from the water surface into a special basket. The skimmer is available in two variants: white ABS (we can paint it in the color of the pool) or stainless steel.



Lamps

Underwater lighting is a crucial element of the pool basin equipment. The number of lamps is selected individually according to the customer's preferences. The cover can be made of white ABS (we can paint it in the color of the pool) or of stainless steel. The bulb is available in the primary option of 300W or the LED version.



The bottom drain

Allows easier drainage of water from the inside of the underwater roller shutter chamber to the outside. The bottom drain can be made of white ABS or stainless steel.



Pumps and filters

Sand filter

Is one of the essential elements of the pool technique used to keep the water clean. Special sand or glass is placed, with the help of which all impurities are removed from the water surface. Filters come in various sizes, depending on the basin's dimensions.



Filter pump

The primary function of the filter pump is to draw water into the filter and release it back to the pool. It's a basic element of the swimming pool technique, without which its proper functioning is impossible. They come in various variants, and their size depends on the size of the pool.

Water purifying

Automatic chemical dosing station

A correctly set device will completely independently dose the correct dose of swimming pool chemicals into the water and allow us to control the current level of preparations in the basin.



Salt ionizer

Is an alternative solution for chemical dosing stations. This device converts salt into chlorine in the process of electrolysis.



UV lamp

Supports water disinfection using UVC radiation. It does not add additional chemicals to the water



Water heating

Heat pumps

The best and most effective way of heating swimming pool water from spring to autumn. The disposable device maintains a constant temperature in the basin throughout the bathing season.



Heat exchanger

We can use this device when the house is heated with a gas or oil stove. The exchanger is connected to the central heating system, heating the water to the appropriately selected temperature.

Accessories

Automatic vacuum cleaner

Moves independently around the pool basin, cleaning every possible place - from the floor to the walls.



The water curtain

Gives the user a remarkable waterfall effect, perfect for relaxing. At the same time, it minimizes fatigue and improves well-being.



The jet swim

Is a device for active users of the swimming pool. The jet swim pump produces a powerful stream of water, which enables intense swimming practically on the spot.



Swimming pool technology



Your own luxury pool

Pool installation

We offer complete installation services from preparing the excavation, ordering the crane, making the bottom plate, as well as filling the pool with semi-dry concrete and connecting the pool filtration. In addition, we provide professional finishing of terrace surfaces with exotic wood.



Transport



Our transport fleet consists of new delivery trucks and specialized trailers for transporting swimming pools. At the same time, our qualified drivers guarantee safety and timely delivery of the transported product.



Mike

Dimension: 2,20 x 1,90 x 1,00m



Josef

Dimension: 2,07 x 2,07 x 1,06m



Victoria

Dimension: 4,70 x 2,70 x 1,30m

Mini Victoria

Dimension: 4,20 x 2,70 x 1,30m



Papeete 600

Dimension: 6,00 x 3,00 x 1,50m

Papeete 700

Dimension: 7,00 x 3,50 x 1,50m



Bali 650

Dimension: 6,50 x 3,70 x 1,50m

Bali 750

Dimension: 7,50 x 3,70 x 1,50m



Wicek

Dimension: 2,30 x 2,90 x 0,90m



Kinderpool

Dimension: 5,00 x 3,00 x 0,50m



Saba 500

Dimension: 5,00 x 3,00 x 1,45m

Saba 600

Dimension: 6,00 x 3,00 x 1,45m



Grenada 600

Dimension: 6,00 x 3,00 x 1,52m

Grenada 700

Dimension: 7,00 x 3,00 x 1,52m



Bahama 600

Dimension: 6,10 x 3,75 x 1,50m

Bahama 1100

Dimension: 11,10 x 3,75 x 1,50m



Tropea
Dimension: 6,20 x 3,70 x 1,50m



Farris 650
Dimension: 6,50 x 3,20 x 1,50m



Aves 705
Dimension: 7,05 x 3,20 x 1,55m



Farris 800
Dimension: 8,00 x 3,20 x 1,50m

Aves 800
Dimension: 8,00 x 3,20 x 1,55m



Tortola 800
Dimension: 8,00 x 3,70 x 1,50m



Haiti
Dimension: 8,00 x 3,20 x 1,52m

Tortola 1000
Dimension: 10,00 x 3,70 x 1,50m



Aruba Plus
Dimension: 8,00 x 3,70 x 1,50m



Panama
Dimension: 8,00 x 3,70 x 1,50m



Barbados
Dimension: 9,40 x 3,70 x 1,50m



Aruba 720
Dimension: 7,20 x 3,70 x 1,50m

Trinidad
Dimension: 9,70 x 3,70 x 1,60m



Aruba 820
Dimension: 8,20 x 3,70 x 1,50m

Hawana
Dimension: 10,00 x 3,70 x 1,50m

Jamaika
Dimension: 11,25 x 3,75 x 1,50m



**Official
distributor
of Europool's
products**

523 Mansfield Road
Nottingham
NG5 2JL
Tel 0330 133 00 36
www.starlightpools.co.uk

